



# 135 PRISMA INTEGRATED AMPLIFIER

User Guide



## CAUTION

TO REDUCE THE RISK OF FIRE, REPLACE WITH THE SAME TYPE AND RATING OF FUSE.

## ATTENTION

UTILISER UN FUSIBLE DE RECHANGE MÊME TYPE.

## Safety compliance

This product has been designed to meet the IEC 60065 international electrical safety standard.

## CAUTION

RISK OF ELECTRIC SHOCK DO NOT OPEN

## ATTENTION

RISQUE DE CHOC ELECTRIQUE NE PAS OUVRIR



The lightning flash with an arrowhead symbol within an equilateral triangle, is intended to alert the user to the presence of uninsulated 'dangerous voltage' within the product's enclosure that may be of sufficient magnitude to constitute a risk of electric shock to persons.



The exclamation point within an equilateral triangle is intended to alert the user to the presence of important operating and maintenance (servicing) instructions in the literature accompanying the product.

**CAUTION:** To reduce the risk of electrical shock do not remove cover (or back). No user serviceable parts inside. Refer servicing to qualified service personnel.

**WARNING:** To reduce the risk of fire or electrical shock, do not expose this apparatus to rain or moisture.

**CAUTION:** In Canada and the USA, to prevent electric shock, match the wide blade of the plug to the wide slot in the socket and insert the plug fully into the socket.

This product is designed and manufactured to meet strict quality and safety standards. However, you should be aware of the following installation and operation precautions.

### 1. Take heed of warnings & instructions

You should read all the safety and operating instructions before operating this appliance. Retain this handbook for future reference and adhere to all warnings in the handbook or on the appliance.

### 2. Water and moisture

The presence of electricity near water can be dangerous.

Do not use the appliance near water – for example next to a bathtub, washbowl, kitchen sink, in a wet basement or near a swimming pool, etc.

### 3. Object or liquid entry

Take care that objects do not fall and liquids are not spilled into the enclosure through any openings. Liquid-filled objects such as vases should not be placed on the equipment.

### 4. Ventilation

Do not place the equipment on a bed, sofa, rug or similar soft surface, or in an enclosed bookcase or cabinet, since ventilation may be impeded. We recommend a minimum distance of 50mm around the sides and top of the appliance to provide adequate ventilation.

### 5. Heat

Locate the appliance away from naked flames or heat producing equipment such as radiators, stoves or other appliances (including other amplifiers) that produce heat.

### 6. Climate

The appliance has been designed for use in moderate climates.

### 7. Racks and stands

Only use a rack or stand that is recommended for use with audio equipment. If the equipment is on a portable rack it should be moved with great care, to avoid overturning the combination.

### 8. Cleaning

Unplug the unit from the mains supply before cleaning.

The case should normally only require a wipe with a soft, damp, lint-free cloth. Do not use paint thinners or other chemical solvents for cleaning.

We do not advise the use of furniture cleaning sprays or polishes as they can cause indelible white marks if the unit is subsequently wiped with a damp cloth.

### 9. Power sources

This appliance must be connected to a mains socket outlet using the supplied power cord. To disconnect this apparatus from power, you must disconnect the power cord. Make sure the power cord is always easily accessible.

Only connect the appliance to a power supply of the type

described in the operating instructions or as marked on the appliance.

This is a Class 1 device and **must** be earthed.

The power switch is a single-pole switch. When the switch is in the "Off" position, the appliance is not completely disconnected from the main power.

### 10. Power-cord protection

Power supply cords should be routed so that they are not likely to be walked on or pinched by items placed upon or against them, paying particular attention to cords and plugs, and the point where they exit from the appliance.

### 11. Grounding

Ensure that the grounding means of the appliance is not defeated.

### 12. Power lines

Locate any outdoor antenna/aerial away from power lines.

### 13. Non-use periods

If the unit has a stand-by function, a small amount of current will continue to flow into the equipment in this mode. Unplug the power cord of the appliance from the outlet if left unused for a long period of time.

### 14. Abnormal smell

If an abnormal smell or smoke is detected from the appliance, turn the power off immediately and unplug the unit from the wall outlet. Contact your dealer immediately.

### 15. Servicing

You should not attempt to service the appliance beyond that described in this handbook. All other servicing should be referred to qualified service personnel.

### 16. Damage requiring service

The appliance should be serviced by qualified service personnel when:

- A. the power-supply cord or the plug has been damaged, or
- B. objects have fallen, or liquid has spilled into the appliance, or
- C. the appliance has been exposed to rain, or
- D. the appliance does not appear to operate normally or exhibits a marked change in performance, or
- E. the appliance has been dropped or the enclosure damaged.

## 2.4G and 5G FCC Statements

This device complies with Part 15 of the FCC Rules. Operation is subject to the following two conditions:

1. This device may not cause harmful interference, and
2. This device must accept any interference received, including interference that may cause undesired operation.

Cet appareil est conforme à la section 15 des réglementations de la FCC. Le fonctionnement de l'appareil est sujet aux deux conditions suivantes :

1. cet appareil ne doit pas provoquer d'interférences néfastes, et
2. cet appareil doit tolérer les interférences reçues, y compris celles qui risquent de provoquer un fonctionnement indésirable.

**Note:** This product has been tested and found to comply with the limits for a Class B digital device, pursuant to Part 15 of the FCC Rules. These limits are designed to provide reasonable protection against harmful interference in a residential installation. This product generates, uses, and can radiate radio frequency energy and, if not installed and used in accordance with the instructions, may cause harmful interference to radio communications. However, there is no guarantee that interference will not occur in a particular installation. If this product does cause harmful interference to radio or television reception, which can be determined by turning the equipment off and on, the user is encouraged to try to correct the interference by one or more of the following measures:

- Reorient or relocate the receiving antenna.
- Increase the separation between the equipment and receiver.
- Connect the equipment into an outlet on a circuit different from that to which the receiver is connected.
- Consult the dealer or an experienced radio/TV technician for help.

Please take attention that changes or modification not expressly approved by the party responsible for compliance could void the user's authority to operate the equipment.

This equipment should be installed and operated with a minimum distance 20cm between the radiator and your body.

Cet équipement doit être installé et utilisé à une distance minimale de 20 cm entre le radiateur et votre corps.

This device complies with Industry Canada licence-exempt RSS standard(s). Operation is subject to the following two conditions:

1. this device may not cause interference, and
2. this device must accept any interference, including interference that may cause undesired operation of the device.

Le présent appareil est conforme aux CNR d'Industrie Canada applicables aux appareils radioexempts de licence. L'exploitation est autorisée aux deux conditions suivantes :

1. l'appareil ne doit pas produire de brouillage, et
2. l'utilisateur de l'appareil doit accepter tout brouillage radioélectrique subi, même si le brouillage est susceptible d'en compromettre le fonctionnement.

Under Industry Canada regulations, this radio transmitter may only operate using an antenna of a type and maximum (or lesser) gain approved for the transmitter by Industry Canada. To reduce potential radio interference to other users, the antenna type and its gain should be so chosen that the equivalent isotropically radiated power (e.i.r.p.) is not more than that necessary for successful communication.

Conformément à la réglementation d'Industrie Canada, le présent émetteur radio peut fonctionner avec une antenne d'un type et d'un gain maximal (ou inférieur) approuvé pour l'émetteur par Industrie Canada. Dans le but de réduire les risques de brouillage radioélectrique à l'intention des autres utilisateurs, il faut choisir le type d'antenne et son gain de sorte que la puissance isotrope rayonnée équivalente (p.i.r.e.) ne dépasse pas l'intensité nécessaire à l'établissement d'une communication satisfaisante.



The CE symbol indicates that this Primare product complies with the EMC (Electromagnetic Compatibility) and LVD (Low Voltage Directive) standards of the European Community.

The WEEE symbol indicates this Primare product complies with the European Parliament and Council Directive 2002/96/EC concerning Waste Electrical and Electronic Equipment (WEEE). This product must be appropriately recycled or processed in accordance with these directives. Consult your local waste disposal authority for guidance.

The RoHS symbol indicates that Primare products are designed and manufactured to comply with the Restriction of Hazardous Substances (RoHS) as stated in the European Parliament and Council Directive 2002/95/EC.

## Copyright and acknowledgments

Copyright © 2018 Primare AB.  
All rights reserved.

Primare AB  
Limstensgatan 7  
21616 Limhamn  
Sweden

<http://www.primare.net>

Issue: I35Prisma/1

The information in this guide is believed to be correct as of the date of publication. However, our policy is one of continuous development and so the information is subject to change without notice, and does not represent a commitment on the part of Primare AB.

Primare is a trademark of Primare AB.

This guide was produced by  
Human-Computer Interface Ltd.  
<http://www.interface.co.uk>



# CONTENTS

## Welcome!

## Getting Started

- 1 Unpack the I35
- 2 Connect speakers
- 3 Connect inputs
- 4 Connect the antennae
- 5 Connect power
- 6 Connect to Wi-Fi

## Back-panel connections

## Using the remote control

- Selecting I35 mode
- Fitting the batteries

## Using the I35

- Front panel controls
- Changing the volume
- Selecting a source
- Changing the display brightness
- Controlling streaming

## Connecting direct sources

## Playing music from a drive or music server

## Streaming music from a phone, tablet, or PC

6	<b>Configuring the settings</b>	14
	Using the settings menus	14
7	INPUT SETTINGS	14
7	AUDIO SETTINGS	15
7	GENERAL SETTINGS	15
7	STREAMING SETTINGS	16
7	NETWORK SETTINGS	16
7	<b>Technical specification</b>	17
	Speaker outputs	17
8	Analogue inputs	17
9	Analogue outputs	17
9	Digital inputs	17
9	Digital output	17
10	Performance	17
10	Network	17
10	General	17
10	<b>Additional information</b>	18
10	Phase	18
10	Burn-in	18
	RS232 and trigger	18
11	Using the I35 with a DD35	18
12	Error messages	18
	Factory reset	18
13	Network troubleshooting	18
	<b>Index</b>	19

# WELCOME!

## **Congratulations on selecting your new I35 Prisma Integrated Amplifier**

This user guide describes the features and explains how to set up the amplifier for the best sound quality and ease of operation in order to allow for the most enjoyable reproduction of sound from all your sources.

For additional support and assistance please contact your local authorized Primare dealer, or visit our website at [www.primare.net](http://www.primare.net).



# GETTING STARTED

## 1 Unpack the I35

Your I35 is supplied with:

- This User Guide
- The Chromecast built-in Quick Start Guide
- Mains cable
- IR cable
- Trigger cable
- Antennas for Bluetooth and Wi-Fi
- C25 remote control with batteries
- AC Polarity Pen

If any of these items are missing please contact your supplier. We recommend you retain the packaging in case you need to transport the unit at a later date.

Note that the I35 is supplied with a protective film on the display glass. Remove the film for a clearer whiter display.

## 2 Connect speakers

The I35 is designed to be connected directly to a pair of loudspeakers.

- Connect the red wire from each speaker to the red terminal marked + and the black wire from each speaker to the black terminal marked –.

The terminals can accept speaker cables terminated with spade terminals, banana plugs, or bare wires.

To connect bare wires unscrew the terminal, pass the bare wire through the hole in the terminal bolt, and clamp the wire in place by screwing the terminal back down hand tight.

### Analogue outputs

The I35 provides fixed-level and variable-level analogue outputs on the LINE and PRE outputs on RCA connectors, to allow you to connect to active speakers or an analogue recorder.

### Digital outputs

The I35 also provides a coax digital output on an RCA connector.

I35 Prisma Integrated Amplifier User Guide

## 3 Connect inputs

You can connect up to two balanced sources, up to three unbalanced sources, and up to six digital sources to the inputs on the back panel.

### Balanced inputs

- Connect balanced sources, such as the Primare CD35 CD player, to balanced inputs A1 and A2 using high quality XLR cables.

### Unbalanced inputs

- Connect unbalanced sources to the unbalanced inputs A3, A4, and A5 using high quality RCA cables.

### Digital inputs

- Connect digital optical sources to the digital optical inputs D6 to D9 using optical cables.
- Connect digital coax sources to the digital coax inputs D10 and D11 using digital RCA cables.

You can also connect a USB flash drive to the USB-A input, and a PC or Mac to the USB-B input to use the I35 as an audio output device for your computer. For more information see *PLAYING MUSIC FROM A DRIVE OR MUSIC SERVER*, page 12.

### Streaming

You can also stream music wirelessly to the I35 from a mobile phone, tablet, computer, or other Prisma product via Bluetooth or Wi-Fi, or via a wired Ethernet connection. For more information see *STREAMING MUSIC FROM A PHONE, TABLET, OR PC*, page 13.

## 4 Connect the antennae

- Connect the two antennae supplied with the I35 to the ANT 1 and ANT 2 sockets on the back panel, and position the two antennae at a slight angle from the vertical.

One antenna is for Bluetooth connectivity, and the other one is for Wi-Fi connectivity.

## 5 Connect power

- Plug one end of the mains cable supplied with the I35 into the power connector on the back panel, and connect the other end to a wall socket.

If this cable is not suitable for your power outlets please contact your supplier for an alternative cable.

**Note:** See *Phase*, page 18, for information about getting the best sound from your I35.



**WARNING:** Always disconnect the I35 from the mains power before connecting or disconnecting any cables.

- Switch on the I35, using the switch on the back panel.

### To switch on from standby

- Press  on the front panel or remote control.

The display shows:

PRIMARE

## 6 Connect to Wi-Fi

When the I35 is ready to set up the network the display will show **Setup mode**.

- Make sure Bluetooth and Wi-Fi are enabled on your mobile device.
- Install the free **Google Home** app on your mobile device.
- Run **Google Home**.

It will display **New device found, I35**.

- Click **SET UP** and follow the instructions.

After playing a test sound you will be prompted to connect to your home Wi-Fi network.

- Select your Wi-Fi network and enter the password.

You will now be able to stream music to your I35.

# BACK-PANEL CONNECTIONS

The following diagram explains the function of each of the connectors on the back panel:

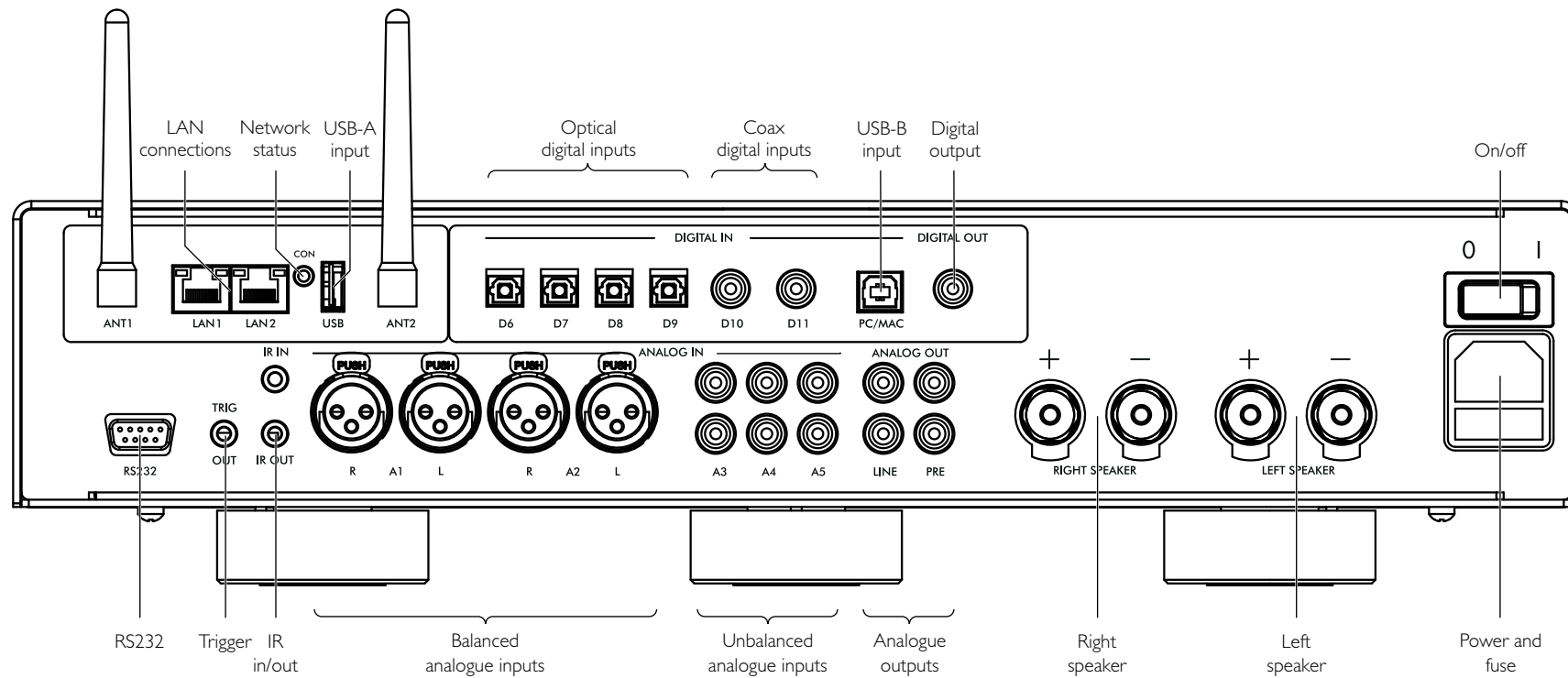



# USING THE REMOTE CONTROL

## Selecting I35 mode

The remote control can operate any associated Primare products you have in your system.

### To make the remote control operate the I35

- Press the **AMP AV** button once.

### To make the remote control operate another product

- Press the **AMP AV**, **CD SC**, or **PRE AUX** button as appropriate.

Press once to select the product on the top line of the button, or twice to select the product on the second line.

The indicators at the top of the remote control light when pressing a button to show which mode the remote control is in.

## Fitting the batteries

Before using the remote control you need to insert the two AAA cells supplied with the C25.

- Open the cover on the back of the remote control by pressing the back cover gently near the centre of the remote control, and sliding it towards the edge of the remote control.
- Insert the two batteries, with the polarity as indicated on the bottom of the battery compartment.
- Replace the cover and push until it clips into place.



**Note:** Replace only with 1.5V alkaline cells type AAA or equivalent.

When disposing of old batteries please be considerate to the environment.

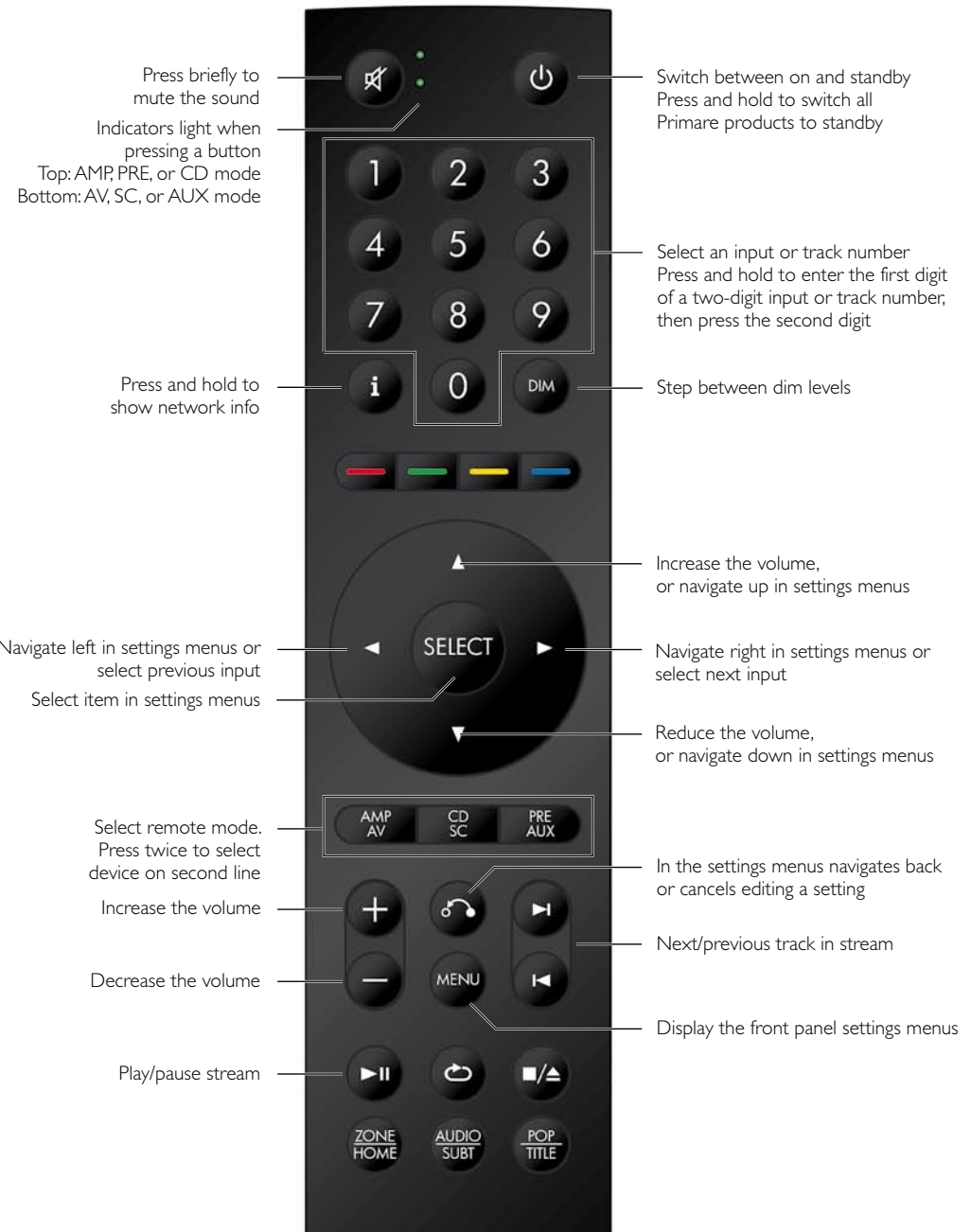

# USING THE I35

## Front panel controls

### Selector

Selects an input. In the settings menus navigates between settings.

### Standby

Switches the I35 to standby, or switches it on from standby.

### Menu

Displays the settings menus or exits from the menus.

### Select

In the settings menus selects a setting or saves an edited setting.

### Back

In the settings menus navigates back or cancels editing a setting.

### Volume

Changes the volume.

## Changing the volume

The I35 allows you to vary the volume from 0 (silence) to 99 (maximum).

### To change the volume

- Rotate the **VOLUME** control on the front panel, or press the **+** or **-** buttons or the **▲** or **▼** buttons on the remote control.

The current volume setting is shown on the front panel; for example:



VOL 28

## Selecting a source

The I35 provides a choice of 12 inputs. Initially these are labelled as shown in the following table, but you can give them your own aliases to suit the sources in your system; see *ALIAS*, page 14.

Label	Description
A1, A2	Balanced analogue on XLR connectors.
A3–A5	Unbalanced analogue on RCA connectors.
D6–D9	Digital optical on TOS connectors.
D10, D11	Digital coax on RCA connectors.
PC/MAC (12)	Digital on USB-B connector.

### To select a source

- Turn the **SELECTOR** until the source is indicated on the front panel display; for example:  

A1
- Alternatively, press the **◀** or **▶** buttons on the remote control to step between sources, or press one of the buttons **1** to **12** on the remote control to select the corresponding source directly.

## Changing the display brightness

### To change the front panel display brightness

- Press the **DIM** button on the remote control to step through the three levels of illumination and blank.

If you turn the display off it will be restored briefly when you operate any control.

The display automatically dims after ten minutes; you can adjust this delay in the settings menus; see *GENERAL SETTINGS*, page 15.

## Controlling streaming

When streaming music to the I35 you can control playback from the front panel or the remote control.

### To select the next or previous track

- Press the **◀** button on the front panel.

The track name will be highlighted on the display:



- Rotate the **SELECTOR** control on the front panel to step between tracks.
- Press the **◀** button again to stop using the **SELECTOR** control to select tracks.

You can also step between tracks using the **◀** or **▶** buttons on the remote control.

### To pause playback

- Press the **▶||** button on the remote control.

Press the **▶||** button again to resume playback.

For more information about streaming see *STREAMING MUSIC FROM A PHONE, TABLET, OR PC*, page 13.

# CONNECTING DIRECT SOURCES

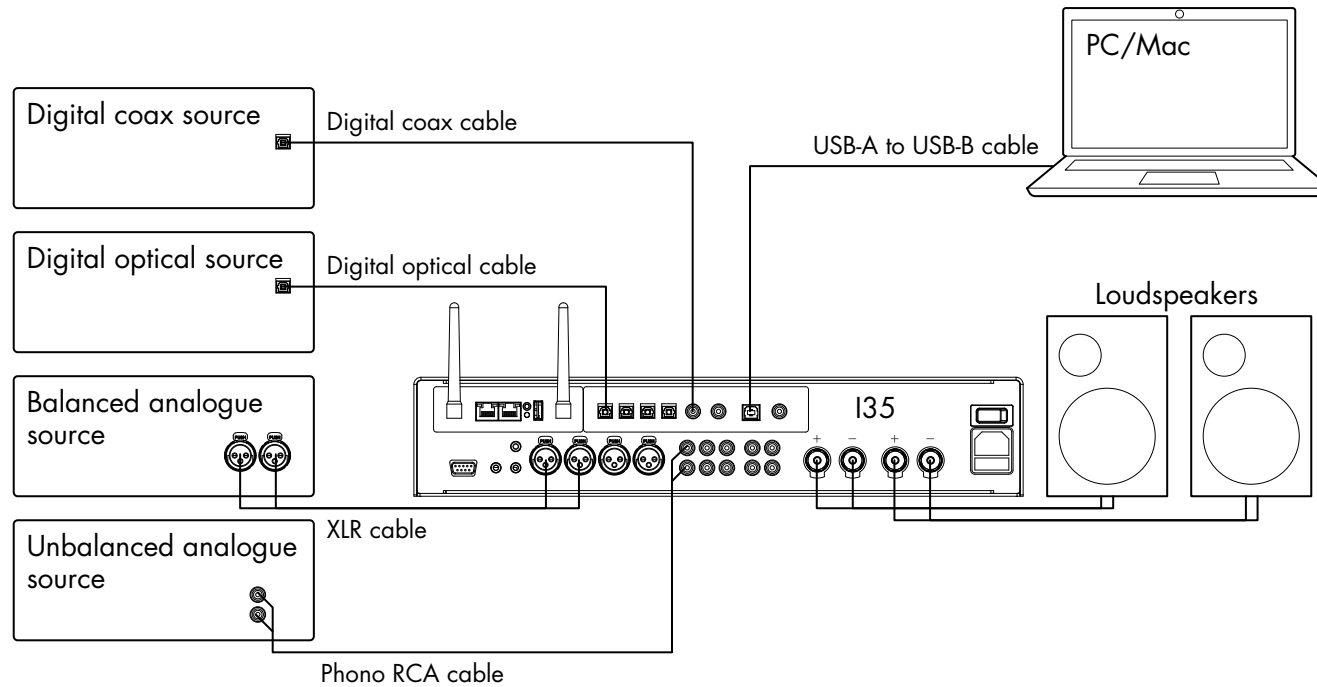

These methods of playing music from the I35 involve connecting the source to the I35 via a cable, and don't require Wi-Fi, Ethernet, or Bluetooth.

## To play music from a source

- Connect the source via a suitable cable:

Balanced analogue	XLR cable
Unbalanced analogue	Phono RCA cable
Digital optical source	Digital optical cable
Digital source	Digital coax cable

- Select the source from the front panel, or using the remote control.

If you have a phone or tablet on the same Wi-Fi network as the I35 you can also use the Prisma app to select and control sources.

## To use the I35 as a PC/Mac sound output device

- Connect the Mac or PC to the I35 via a USB-A to USB-B cable.

### PC

Windows 7, 8, 8.1, or 10 (32/64-bit) is required. You need to install the Primare xmos audio driver, available on [primare.net](http://primare.net).

### Macintosh

OSX 10.4 or later is recommended. No driver is required.

- Connect the computer's USB port to the USB B input on the I35 using a USB A to USB B cable.

The I35 will then appear as a sound output device called **I35** in the Sound control panel (PC) or Sound system preferences panel (Macintosh).

- Select the PC/MAC source on the I35.

- Select the I35 as the sound output device in the Mac Sound system preferences panel or the PC Sound control panel.

# PLAYING MUSIC FROM A DRIVE OR MUSIC SERVER

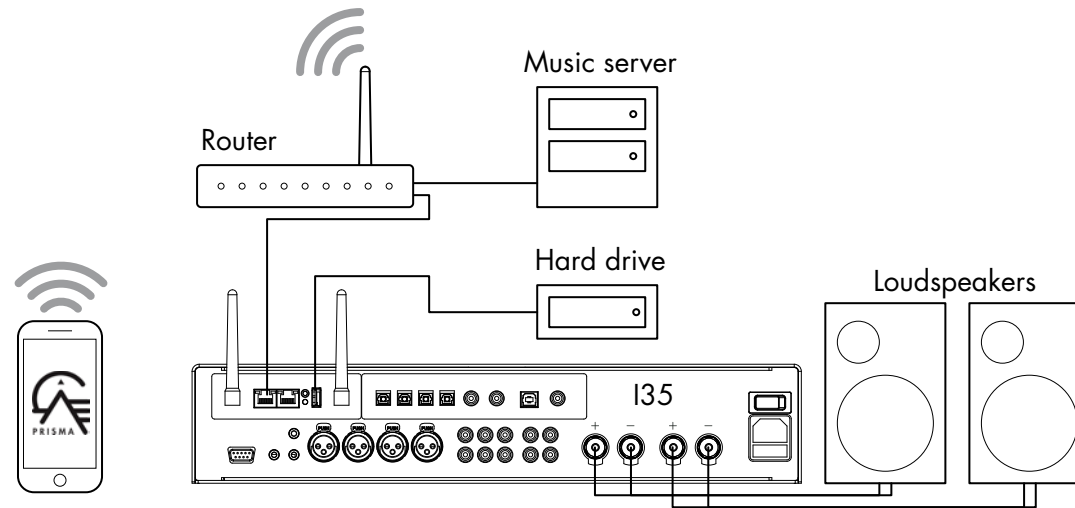

You can play audio files from a USB flash drive, external USB hard disk, or a network drive. These options are ideal if you already have a digital library of CDs or music files.

On a USB flash drive or USB hard disk the files can be organised into folders, giving you one way of classifying your music; eg by Artist.

On a NAS drive you have the option of running a media server program, which will catalogue your music library and give you the option of organising it in different ways; eg by Artist, Genre, Album, or Composer. One free option is MinimServer; see <http://minimserver.com/>.

## To play audio files from a USB flash drive or hard drive

- Connect the USB drive to the USB-A input on the I35.

The USB drive can contain folders and music files in any of the popular formats; see *TECHNICAL SPECIFICATION*, page 17, for details.

- Use the Prisma app to browse, play, and control the music.

## To play audio files from a NAS (network) drive

- Connect the NAS drive to the same network as the I35.

The NAS drive can either contain folders and music files in any of the popular formats, or it can run a music server. See *TECHNICAL SPECIFICATION*, page 17, for details of the supported file formats.

- Use the Prisma app to browse, play, and control the music.

Alternatively you can select and play music from a Mac or PC using a music server program such as JRiver or Foobar2000.

# STREAMING MUSIC FROM A PHONE, TABLET, OR PC

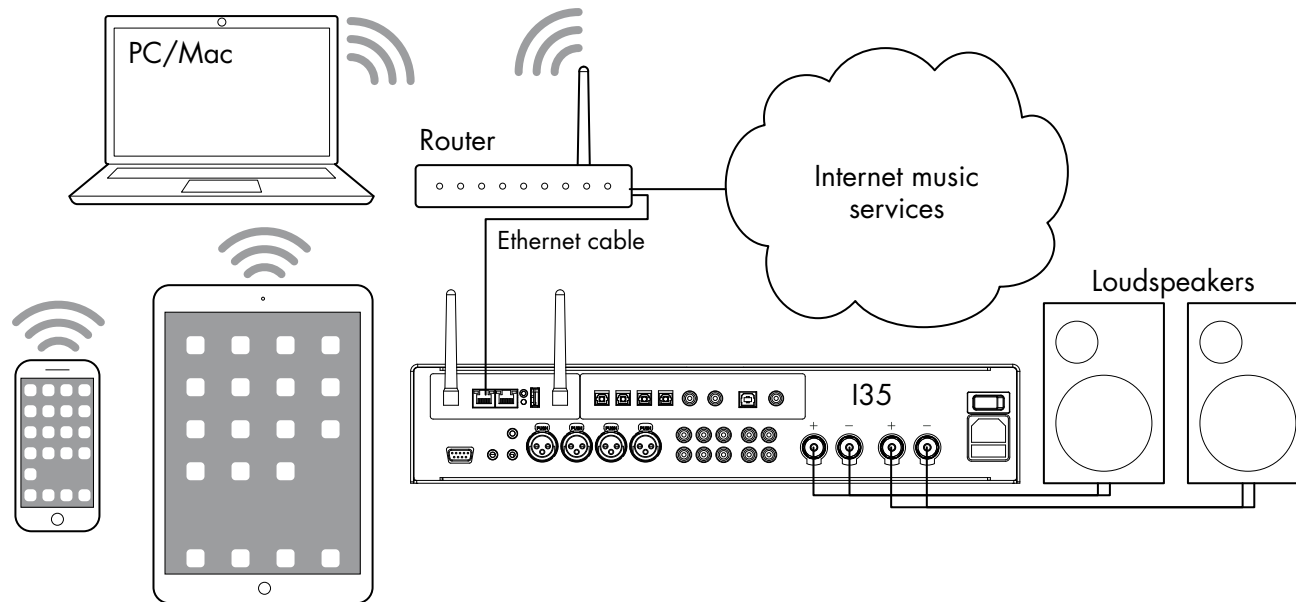

The I35 can use Chromecast to connect directly to a music service that supports Chromecast, such as Spotify, Deezer, Tidal, or TuneIn Radio. The music is streamed direct to the I35; once set up you can use your phone to make calls, or play other audio.

With a phone, tablet, or Mac/PC you can also play the audio wirelessly to the I35, using Bluetooth or AirPlay (iOS only), so the sound from any apps you run on your device will be played through the I35.

Although you can stream music over Wi-Fi, for best results connect the I35 to your home router via an Ethernet cable. If necessary, use the Google Home app to configure the network settings on your I35.

## To stream using Chromecast

The I35 has Chromecast built-in, which means you can stream (cast) music over your network directly to the I35 from any Chromecast supported music service, using the music service's app on your desktop or mobile device as a controller.

- Click the Cast button within your music service's app and select the I35 in the device list.

## To stream using AirPlay

Use AirPlay to send audio over the network from your Apple device to the I35. AirPlay is only available on Apple devices.

## To stream using Bluetooth

Use Bluetooth to send audio directly to the I35 from your Bluetooth device using Bluetooth connection. You don't need a network to stream using Bluetooth.

## To stream using Spotify Connect

The I35 supports Spotify Connect, which means you can stream music directly to the I35 from the Spotify music service over your network, using the Spotify app on your desktop or mobile device as a controller.

Here are Spotify's instructions:

### Listen out loud with Spotify Connect

1. Connect the I35 to your wifi network.
2. Open up the Spotify app on your phone, tablet or laptop using the same wifi network.
3. Play a song and select **Devices Available**.
4. Select the I35 and start listening.

# CONFIGURING THE SETTINGS

## Using the settings menus

You can view and change the I35 settings from the front panel, remote control, or using the Prisma app.

### To display the settings menu

- Press the **⏏** button on the front panel, or the **MENU** button on the remote control.

The settings menu is displayed:



### To step between settings

- Turn the **SELECTOR** control on the front panel, or press the **▲** or **▼** buttons on the remote control.

The current setting is shown highlighted.

### To change a setting

- Press the **←** button on the front panel, or the **SELECT** button on the remote control.

The current value is shown highlighted.

- Turn the **SELECTOR** control on the front panel, or press the **▲** or **▼** buttons on the remote control, to change the value of the setting.

As you change it the new value is shown in the menu.

- Press the **←** button on the front panel, or the **SELECT** button on the remote control, to save the value you have set.

### To navigate back or cancel editing a setting

- Press the **↶** button on the front panel or remote control.

### To exit from the settings menu

- Press the **⏏** button on the front panel, or the **MENU** button on the remote control.

## INPUT SETTINGS

The **INPUT SETTINGS** menu allows you to customise the inputs to suit the sources in your system:



### INPUT

Initially the **INPUT SETTINGS** shows the settings for the currently selected input. Alternatively the **INPUT** option allows you to step between all the inputs. The subsequent options will change according to the input.

### ALIAS

Allows you to give the source a name; eg **RADIO**.

- Highlight the **ALIAS** item, then press the **SELECT** button on the remote control.

The **RENAME INPUT** menu is displayed:

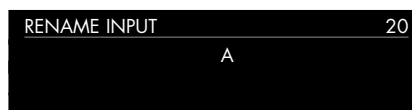

- Turn the **SELECTOR** control on the front panel, or press the **◀** or **▶** buttons on the remote control, to select the first letter.
- Press the **←** button on the front panel, or the **SELECT** button on the remote control, to select it.

After adding each character you have the options:

**ADD NEW CHARACTER**  
**CONFIRM 'A'**  
**CLEAR ALIAS**

where **CONFIRM** shows the alias you have entered so far.

- Select **ADD NEW CHARACTER** to add the remaining letters, up to a maximum of six characters.
- Select **CONFIRM** when you have entered the alias you want.

### STATUS

Choose between **ENABLED** (default) or **DISABLED** to specify whether the input is enabled.

### AUTO SENSE

Choose between: **SELECT** to automatically select an input containing an audio signal if the I35 is on; **WAKE+SELECT** to automatically wake up the I35 from standby, if necessary, and select an input containing an audio signal; and **OFF** (default) to disable automatic switching.

### VOLUME

Choose between **VARIABLE** (default) or **FIXED** to specify whether the input should have variable or fixed gain.

**FIXED** is 0dB gain, equivalent to volume setting 66, and will overrule **MAXIMUM VOLUME** in **AUDIO SETTINGS**.

Selecting **FIXED** will show a loud-volume warning. Select **YES** to proceed or **NO** to cancel the fixed gain setting.

Fixed gain functions as an SSP (Surround Sound Pass-through) allowing the I35 to be used as an amplifier in a multi-channel system setup

### INPUT GAIN

Choose between: -30dB to -1dB, 0dB (default), or +1dB to +30dB to set the gain for the selected input.

If the gain is set too high on an input clipping may occur, and the message:

### DECREASE INPUT GAIN

will be displayed. In this case reduce the gain until the warning message is not displayed.

## AUDIO SETTINGS

The **AUDIO SETTINGS** menu allows you to customise the balance and start-up volume, and the maximum and mute volume.

AUDIO SETTINGS	20
BALANCE	00LR00
STARTUP VOLUME	30
MAXIMUM VOLUME	99

### BALANCE

Allows you to adjust the balance between 00LR-9 (far left), 00LR00 (centred, default) and -9LR00 (far right).

### STARTUP VOLUME

Sets the general startup volume to between 0 and 60. The default is 20.

### MAXIMUM VOLUME

Sets the maximum volume limit between 0 and 99. The default is 99.

### MUTE VOLUME

Sets the volume when unit is muted. You can choose between 0 (default) and 30.

If the current volume is lower than the specified **MUTE VOLUME**, the volume will be set to 0 when pressing mute.

### DIGITAL OUTPUT

Allows you to choose the sample rate for analogue inputs on the digital output as **96kHz** (default) or **48kHz**. For digital inputs the output format is the same as the input.

## GENERAL SETTINGS

The **GENERAL SETTINGS** menu allows you to configure the general operation of the I35:

GENERAL SETTINGS	20
FRONT PANEL	UNLOCKED
AUTO-DIM	AFTER 10MIN
LED BRIGHTNESS	

### SHOW INPUTS

Choose between **ALL** (default), to show all inputs, or **WITH SIGNAL**, to show only inputs that have a signal.

### FRONT PANEL

Choose **LOCKED** to lock the front panel buttons and knobs, or **UNLOCKED** (default) to use them.

To unlock the front panel buttons use the remote control to select this menu, or remove power from the I35 for a few seconds.

### AUTO-DIM

Allows you to choose the delay for dimming the display after no user interaction, between: **AFTER 1MIN**, **AFTER 5MIN**, **AFTER 10MIN** (default), or **OFF**.

### LED BRIGHTNESS

Displays the **LED BRIGHTNESS** menu to allow you to set the display brightness to between 1 and 5 for each display dimming level:

**DIM HIGH** (default 3), **DIM MID** (default 2), **DIM LOW** (default 1), or **DIM OFF** (default 1).

### STANDBY SETTINGS

Displays the **STANDBY SETTINGS** menu to allow you to specify the standby settings.

**STANDBY MODE** can be set to **ECO** to reduce the standby consumption to less than 0.5W, but only allows the I35 to wake from the analogue and digital inputs, or **NORMAL** which also allows the I35 to wake from streaming and the PC/MAC input.

**AUTO-STANDBY** automatically switches the I35 to standby if there is no user interaction or audio from the current source for a specified delay: **AFTER 10MIN**, **AFTER 15MIN**, **AFTER 20MIN** (default), or **OFF**.

**Note:** The **AUTO-STANDBY** function will be disabled if the network has not been set up.

### FACTORY RESET

Resets the I35 to the factory default settings.

You are prompted to confirm. Select **YES** to proceed or **NO** to cancel.

### FIRMWARE VERSIONS

Displays the **FIRMWARE VERSIONS** menu to allow you to view the versions of firmware installed.

## STREAMING SETTINGS

Allows you to configure the I35 streaming:

STREAMING SETTINGS	20
METADATA	ON
BLUETOOTH SETTINGS	
AIRPLAY PASSWORD	

### METADATA

Allows you to choose **ON** (default) or **OFF** to specify whether metadata, such as the artist name and song title, should be displayed.

### BLUETOOTH SETTINGS

Displays the **BLUETOOTH SETTINGS** menu.

**VISIBLE** can be set to **ON** to make the I35 visible to other Bluetooth devices, or **OFF** (default) to make the I35 not visible.

**Note:** **VISIBLE** allows any Bluetooth-enabled device within range to discover and pair with your I35.

**AUTO-CONNECT** can be set to **ON** to automatically connect to a paired bluetooth device when it's within range, or **OFF** (default) to disable automatic connection.

### AIRPLAY PASSWORD

Allows you to set an optional password for connection by AirPlay. Leave empty for no password.

## NETWORK SETTINGS

Allows you to configure the network connection:

NETWORK SETTINGS	20
QUICK INFO	

### QUICK INFO

Shows the **NETWORK INFO** screen with the following information:

- Connection: one of **CONNECTED BY WIFI**, **CONNECTED BY CABLE**, or **NOT CONNECTED**.
- **NETWORK**, the current SSID.
- **IP**, the current IP address.
- **DEVICE NAME**, the device name.
- **WIFI MAC**, the Wi-Fi MAC address.
- **BT MAC**, the current Bluetooth MAC address.

You can also display this information by holding down the **i** button on the remote control.



# TECHNICAL SPECIFICATION

## Speaker outputs

### Power

2 x 150W into 8Ω, 2 x 300W into 4Ω

## Analogue inputs

### Balanced inputs

2 x XLR, 30kΩ impedance

### Unbalanced inputs

3 x RCA, 15kΩ impedance

## Analogue outputs

### Preamplifier output

1 x RCA, 100Ω impedance

### Line output

1 x RCA, 100Ω impedance

## Digital inputs

4 x Optical/TOSLINK 192kHz/24 bit

2 x RCA 192kHz/24 bit

1 x USB-A up to 192kHz/24 bit; up to DSD128 (5.6MHz)

1 x USB-B up to 768kHz/32 bit; up to DSD256 (11.2MHz)

## Digital output

1 x RCA

Analogue input = selectable between 48 or 96kHz

Digital input = native output

## Performance

### Gain

Preamplifier output: 16.5dB

Line output: 0dB

Speaker output: 42.5dB

### Analogue frequency response

20Hz – 20kHz: -0.2dB

### Distortion

THD + N: < 0.05%, 20Hz – 20kHz, 10W at 8Ω

### Signal to noise

>100dB (AES17 filter)

## Network

### Connectivity

2 x Ethernet LAN ports

2 x Antennas for Bluetooth and Wi-Fi

LAN: 10/100Mbit Ethernet port

WLAN: IEEE 802.11 a/b/g/n/ac compliant; 2.4/5GHz; b, g, n mode

### Audio formats

WAV, LPCM, AIFF, FLAC, ALAC, WMA, OGG: Up to 192kHz/24bit

MP3, MP4 (AAC): Up to 48kHz/16bits, VBR & CBR 320kbps

DSD: Up to DSD128 (5.6MHz)

### Streaming

Airplay®

Bluetooth®

Chromecast built-in®

Spotify Connect®

DLNA/UPnP

## General

### Control

C25 system remote control

RS232

IR in/out

Trigger out

### Power Consumption

Standby (ECO): <0.5W

Standby (NORMAL): <6W

Operating: <42W

### Dimensions

430 x 420 x 106 mm (w x d x h) with knobs and connectors

430 x 382 x 106 mm (w x d x h) without knobs and connectors

### Weight

11 kg

### Colour

Black or titanium

# ADDITIONAL INFORMATION

These instructions help you get the best possible sound from your I35.

## Phase

The phase of the AC supply can make a significant difference to the sound.

Use the Polarity Pen supplied with the I35 to verify which pin is live on your AC power cable.

Ensure that the live pin of the AC power cable is connected to the left-hand pin of the power connector, viewed from the back panel:

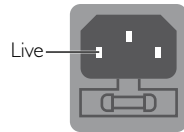

## Burn-in

Your Primare will start to sound best after an initial burn-in of approximately 24 hours.

You will notice a further smaller improvement in sound quality for at least another 3 days' playing.

## RS232 and trigger

The RS232 input allows you to connect the I35 to a controller system. Use a twisted (null modem) cable. For more information contact Primare at [info@primare.net](mailto:info@primare.net) or visit [www.primare.net](http://www.primare.net).

The Trigger output allows the I35 to switch on other devices, such as a DD35.

## Using the I35 with a DD35

Your I35 is an ideal companion to the Primare DD35 CD Transport. For best results link the two products together as follows using the two cables supplied with the I35:

### To connect the trigger cable

The Trigger cable ensures that the DD35 switches on, or to standby, when you operate the ⏻ button on the front panel of the I35.

- Connect the Trigger cable from the I35 TRIG OUT to the DD35 TRIG IN.

## Error messages

The following error messages on the front panel display indicate an error condition:

### DECREASE INPUT GAIN

Clipping has occurred on an input. Decrease the input gain; see *INPUT GAIN*, page 14.

### DC ERROR

Try the following

- Power off I35 and disconnect the speaker connections.

If this solves the problem, check the speaker wiring.

If the problem persists

- Power off I35 and disconnect all input connections.

If this solves the problem, there is a DC offset on one of the inputs.

If the problem persists

- Contact your dealer for service arrangements.

## Factory reset

Press and hold the ⏻ standby button on the front panel to display the main firmware version number.

Press and hold the ⏻ standby button on the front panel for 10 seconds to perform a factory reset of the I35.

You can also do a factory reset from the Prisma app, or from the **GENERAL SETTINGS** menu; see *GENERAL SETTINGS*, page 15.

## Network troubleshooting

### Front panel display

The front panel display indicates the type of network connection:

**LAN** indicates that you are connected by an Ethernet cable.

**WiFi** indicates that you are connected by wireless.

### Network status

The **CON** indicator on the back panel indicates the network status:

**ON** Indicates the I35 is connected to a network

**OFF** Indicates no connection to a network

**Flashing** indicates that the network needs to be configured using the Google Home app.

## Spotify Connect

The Spotify Software is subject to third party licenses found here:

[https://beta.developer.spotify.com/private-documentation/esdk-third\\_party\\_licenses](https://beta.developer.spotify.com/private-documentation/esdk-third_party_licenses)

# INDEX

## A

- AirPlay, streaming 13
- AirPlay password (settings menus) 16
- Alias (settings menus) 14
- Analog inputs and outputs 8
- Antennae, connecting 7
- Audio settings menu 15
- Auto-dim (settings menus) 15
- Auto sense (settings menus) 14

## B

- Back panel 8
- Balance (settings menus) 15
- Balanced inputs 8
- Bluetooth, streaming 13
- Bluetooth settings (settings menus) 16

## C

- Chromecast, streaming 13
- Clipping 14
- Coax inputs 8

## D

- Digital inputs and output 8
- Digital output (settings menus) 15
- Display brightness, changing 10

## E

- Error messages 18

## F

- Factory reset 18
- Factory reset (settings menus) 15
- Firmware (settings menus) 15
- Front panel (settings menus) 15
- Front panel controls 10

## G

- General settings menu 15

## H

- Hard disk, playing music from 12

## I

- Input (settings menus) 14
- Input gain (settings menus) 14
- Inputs, connecting 7
- Input settings menu 14
- IR input 8

## L

- LED brightness (settings menus) 15

## M

- Maximum volume (settings menus) 15

### Menus

- Audio settings 15
- General settings 15
- Input settings 14

### Menus (continued)

- Network settings 16
- Streaming settings 16
- Metadata (settings menus) 16
- Mute volume (settings menus) 15

## N

- Network drive, playing music from 12
- Network settings menu 16
- Network troubleshooting 18
- Next track, selecting 10

## O

- Optical inputs 8

## P

- Pausing playback 10
- PC/Mac sound output device 11
- Phase 18
- Power, connecting 7

## Q

- Quick info (settings menus) 16

## R

- Remote control 9
  - Fitting batteries 9
- RS232 input 8, 18

## S

- Settings menus 14
- Show inputs (settings menus) 14, 15
- Sources
  - Connecting 11
  - Selecting 10
- Speakers, connecting 7
- Spotify Connect, streaming 13
- Standby settings (settings menus) 15
- Startup volume (settings menus) 15
- Status (settings menus) 14
- Streaming 7, 13
  - Pausing playback 10
  - Selecting the next or previous track 10
- Streaming settings menus 16

## T

- Technical specification 17
- Trigger outputs 8

## U

- Unbalanced inputs and outputs 8
- USB flash drive, playing music from 7, 12

## V

- Volume (settings menus) 14
- Volume, changing 10

## W

- Wi-Fi, connecting to 7

# P R I M A R E

THE SOUND AND VISION OF SCANDINAVIA SINCE 1986

LIMSTENSGATAN 7,  
216 16 LIMHAMN, SWEDEN

More information at [primare.net](http://primare.net)

